

Liquid Chromatograph Mass Spectrometer

# LCMS-8060NX

**UFMS**  
ULTRA FAST MASS SPECTROMETRY





SHIMADZU

POWER STATUS HEATER GAS HV

# Enhanced performance

## Sensitivity and Robustness

### LCMS-8060NX

The LCMS-8060NX is a triple quadrupole mass spectrometer with world-class sensitivity and detection speeds. It boasts increased robustness and ease of use as well as Analytical Intelligence to maximize your laboratory's output.

The culmination of Shimadzu's expertise in triple quadrupole mass spectrometry

Robustness and ease of use in high sensitivity analysis

Streamlined analytical process improves workflow efficiency

#### Shimadzu Triple Quadrupole LC/MS

Advancements in sensitivity

##### ● LCMS-8060NX

×3.0

##### ● LCMS-8050

×2.5

##### ● LCMS-8045

×4.0

##### ● LCMS-8040



ANALYTICAL INTELLIGENCE

- Automated support functions utilizing digital technology, such as M2M, IoT, and Artificial Intelligence (AI), that enable higher productivity and maximum reliability.
- Allows a system to monitor and diagnose itself, handle any issues during data acquisition without user input, and automatically behave as if it were operated by an expert.
- Supports the acquisition of high quality, reproducible data regardless of an operator's skill level for both routine and demanding applications.

# The Culmination of Shimadzu's Expertise in Triple Quadrupole Mass Spectrometry

## ■ IonFocus™ unit **NEW**

A newly-developed ESI probe with focus electrodes introduces ions into the mass spectrometer more efficiently, while expelling contaminants to reduce noise and provide more stable data. In addition, an improved heat-assist design promotes the ionization of a wide range of compounds. (Patented technology.)



Simple design without cables or tubes. Remove or replace easily with the "one-touch" lever.

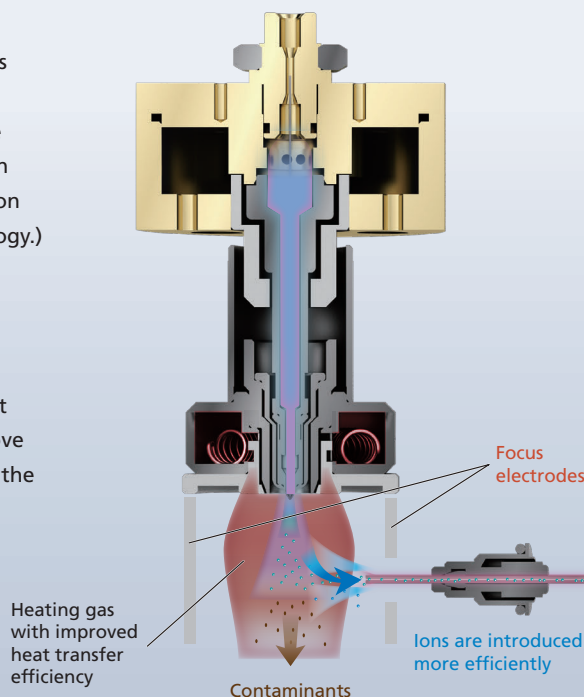

## ■ Ultra-fast power supply

The unique high-voltage power supply enables high-speed polarity switching in 5 ms for high-throughput simultaneous analysis of multiple analytes.

## ■ Easy maintenance interface

The LCMS-8060NX inherits all the ease-of-maintenance of its predecessors. Both the desolvation line (DL), which introduces the sample into the vacuum, and the ESI capillary can be replaced easily and in a short time. The DL can be replaced while maintaining the vacuum, minimizing downtime.

### • Steps to replace the DL

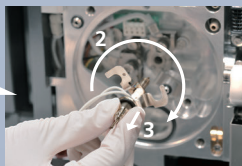
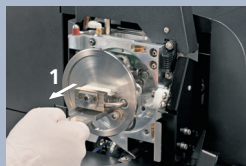

### • Steps to replace the ESI capillary



### ■ UFsweeper™ III collision cell

UFsweeper is a unique Shimadzu technology which effectively sweeps ions from the collision cell without deceleration. Crosstalk is virtually eliminated and high-sensitivity analysis is maintained, even at high acquisition speeds. The high-speed transport technology of UFsweeper III minimizes ion loss even at the highest data acquisition rate of 0.8 msec. Increase laboratory throughput with an MRM speed of 555 channels per second.

### ■ Ultra-fast detector

A detector boasting ultra-fast response enables sensitive and stable signal detection even with a short pause time, dwell time and polarity switching time.

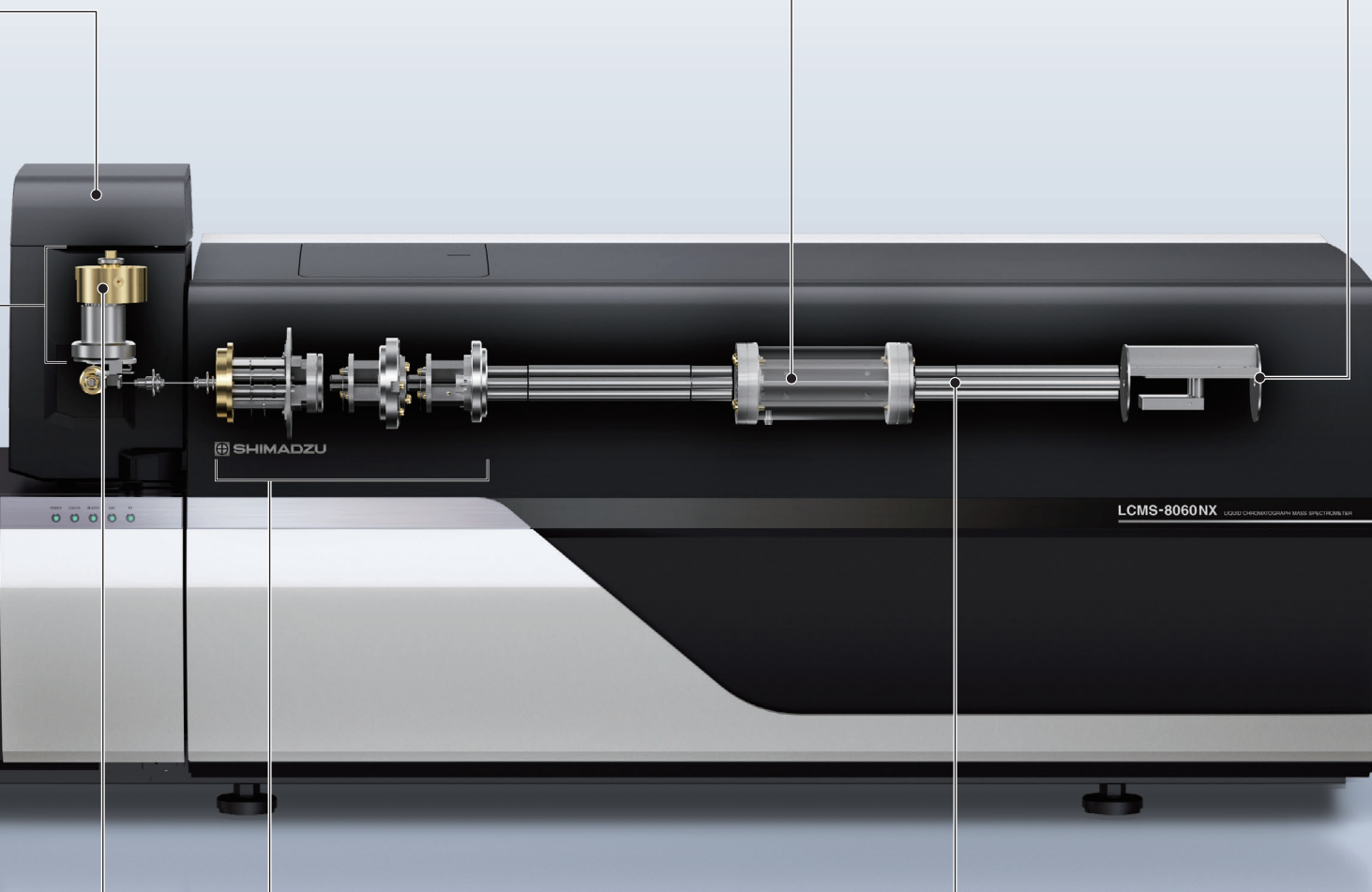

### ■ UF-Qarray™ II , UF-Lens™ II **NEW**



Re-engineered ion guide improves robustness without compromising on sensitivity. Maintenance of UF-Qarray II and UF-Lens II can be performed easily without tools.

### ■ Quadrupole rods

A high-performance hyperbolic mass filter with a proven track record maintains high ion transmittance and high sensitivity, even at a scanning rate of 30,000 u/s.

# Robustness and Ease of Use

## Maximized sensitivity, minimized matrix effects

In the newly-developed IonFocus unit, the focus electrodes reduce sensitivity loss from matrix effects by expelling contaminants with greater efficiency. The contaminants below show an analysis example of residual pesticides in crops. Using the LCMS-8060NX's world-class polarity reversal speed (5 ms) and data capture speed (1.5 ms), stable data was obtained even for high-speed analysis of multiple components. The IonFocus unit also introduces ions into the mass spectrometer more efficiently, improving the signal intensity. Of the 100 compounds tested, 96% showed excellent recoveries.

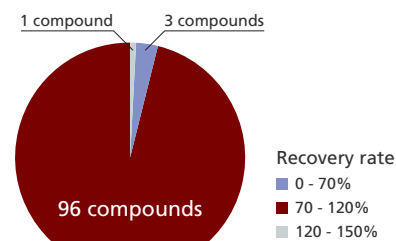
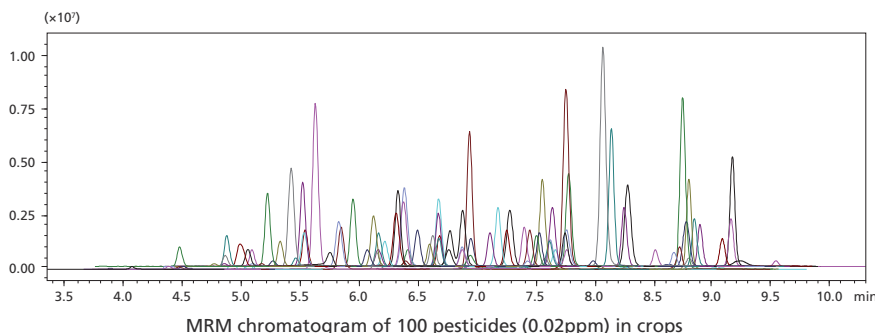
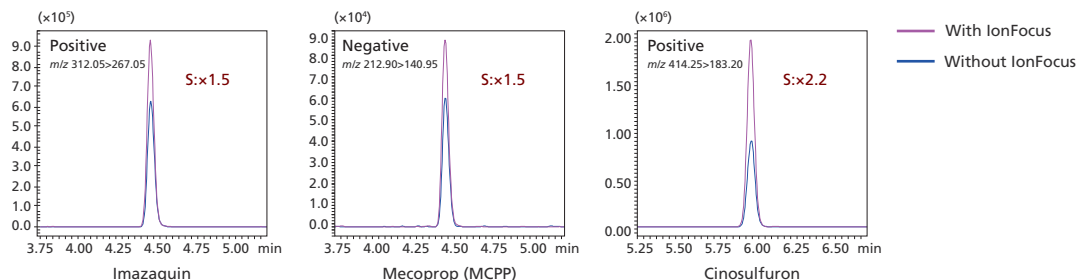

Excellent recovery rate among 100 pesticides

## Superior robustness

The LCMS-8060NX employs new ion guides, the UF-Qarray II and the UF-Lens II, to increase robustness while maintaining high ion transmission efficiency. Improved robustness means higher laboratory throughput as maintenance interval times increase.

The urine metabolite data shown below provides confidence for the analysis of biological matrices. After the analysis of 1000 urine samples, prepared only by dilution with water, the LCMS-8060NX delivers superior data stability without loss of sensitivity.

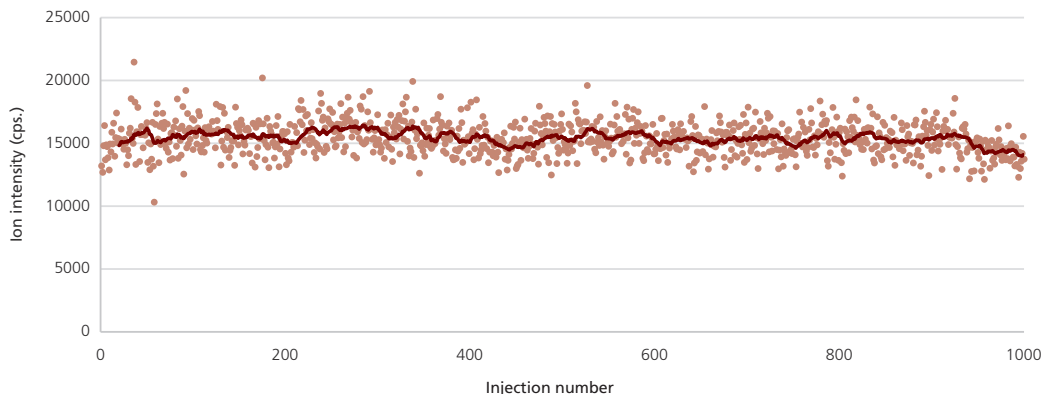

Analytical results of repeated injections of metabolites in urine

## New AI-derived parameters optimized for a wide range of compounds

The LCMS-8060NX uses new default parameters optimized for a wide range of compounds based on research with AI (Artificial Intelligence) processes, enabling excellent results without the need for labor-intensive investigation of analysis conditions. As shown below, this boosts the signal intensity for a variety of target compounds to an average of 2.6 times the intensity achieved with previous parameters.

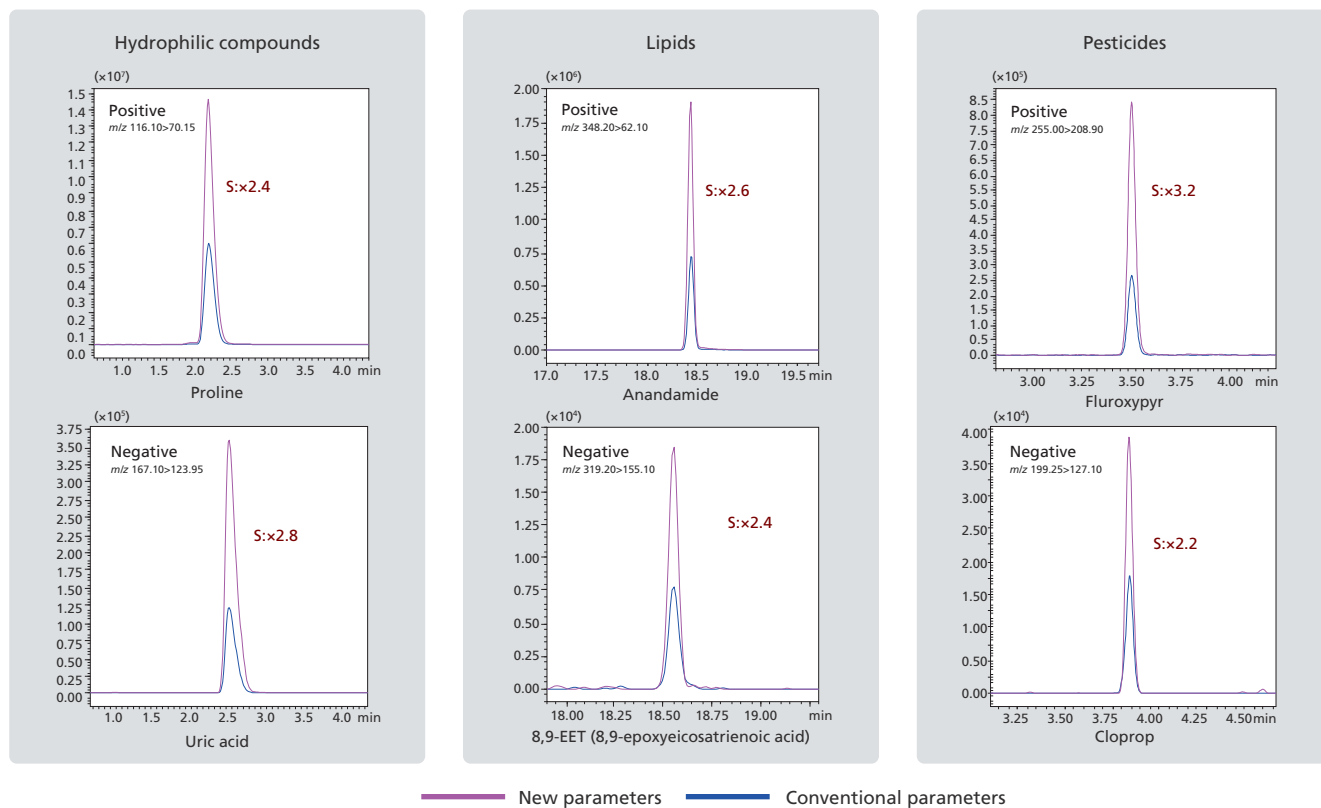

## Efficient desolvation for higher efficiency

A new heat-assisted design improves the desolvation efficiency and dramatically enhances the sensitivity for challenging molecules such as steroid hormones.

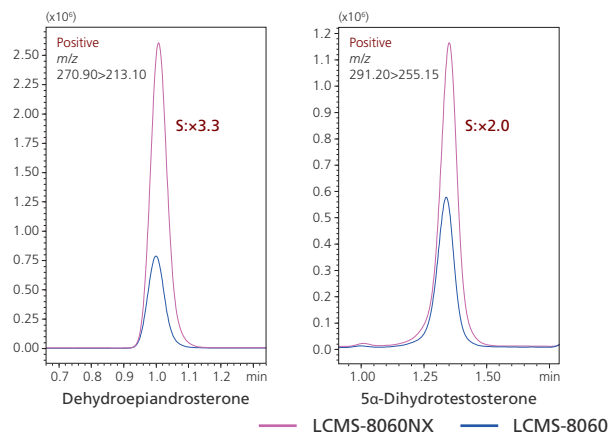
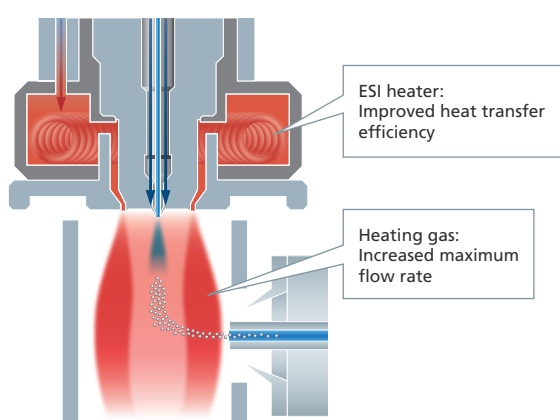

# Intelligent Automation Improves Workflow Efficiency



The combination of the LCMS-8060NX and the Nexera™ series UHPLC provides a system with multiple Analytical Intelligence features, improving the efficiency of your entire workflow and maximizing laboratory throughput.

## Intelligent start-up with Smart Flow Control

HPLC columns can be damaged by sudden pump starts and stops or extreme gradient changes. The Nexera automatically uses FlowPilot (Smart Flow Control) to increase the flow rate gradually to the set point. There is no need to create startup protocols for each analysis.

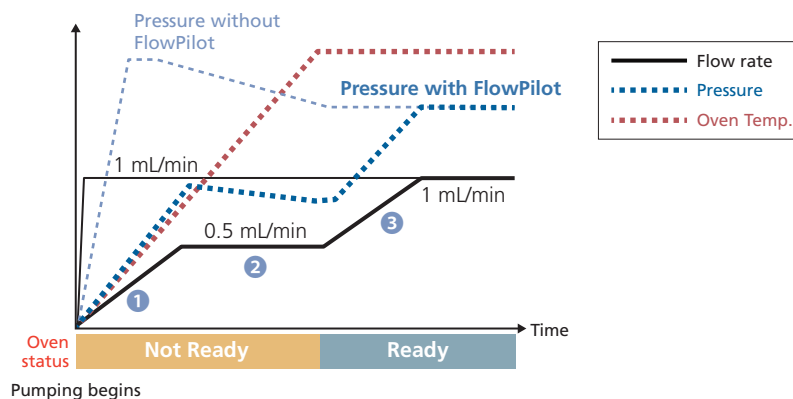

## Improves data processing throughput

Great time savings can be achieved in multiple component data analysis, with functions to check multiple chromatograms at once, display results that exceed standard values in a different color, etc. In addition, several report format templates are provided, reducing the time needed for report creation.

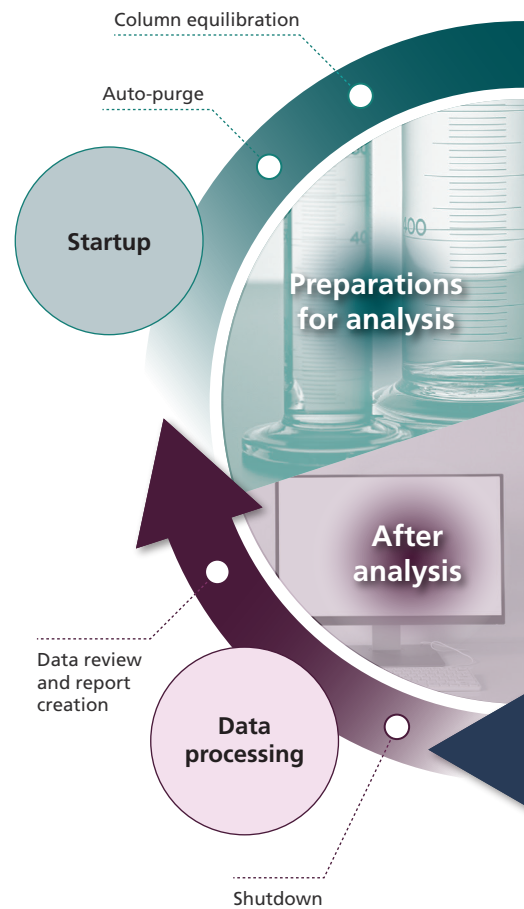
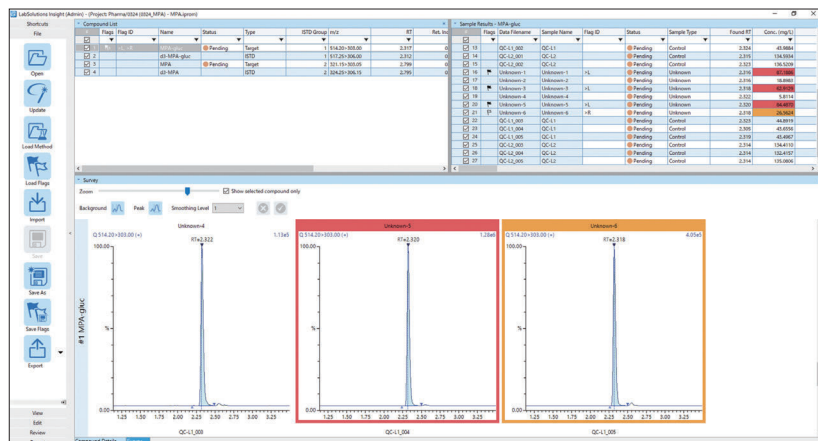



## Automatic optimization of MS conditions

Simply set the sample in place and enter the sample information, and MRM and interface parameter optimization will be carried out automatically. The optimization results are shown graphically, reducing the time and effort needed for evaluation.

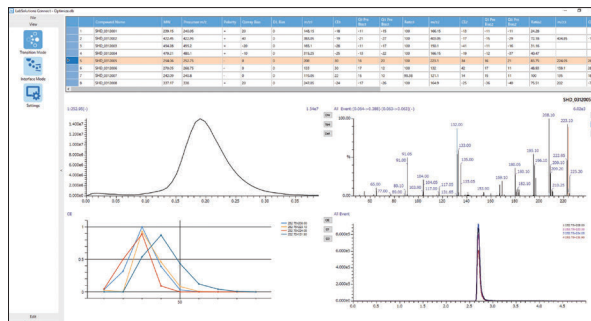

## LC/MS/MS Method Packages and MRM Libraries

Several method packages are available for quick method startup. Analysis can begin right away without MRM optimization or tedious method development.

### Method packages

Target	Cat. No.
Residual Pesticides	C146-E348
Veterinary Drugs	C146-E387
Water Quality Analysis	C146-E180A
Rapid Toxicology Screening	C146-E406
Endogenous Metabolites	C146-E401
Lipid Mediators	C146-E381
Cell Culture Profiling	C146-E408
D/L Amino Acids	C146-E336
Mycotoxins	C146-E351
Forensic Toxicology Database	C146-E388
Short-chain Fatty Acids	C146-E355
Aminoglycoside Antibiotics	C146-E352
Restricted Chemicals in Textiles	C146-E382

### MRM libraries

Target	Cat. No.
Metabolic Enzymes in Yeast	C146-E275
Phospholipid Profiling	C146-E314



Note: optimization of analysis parameters for the LCMS-8060NX is necessary to use some of these products

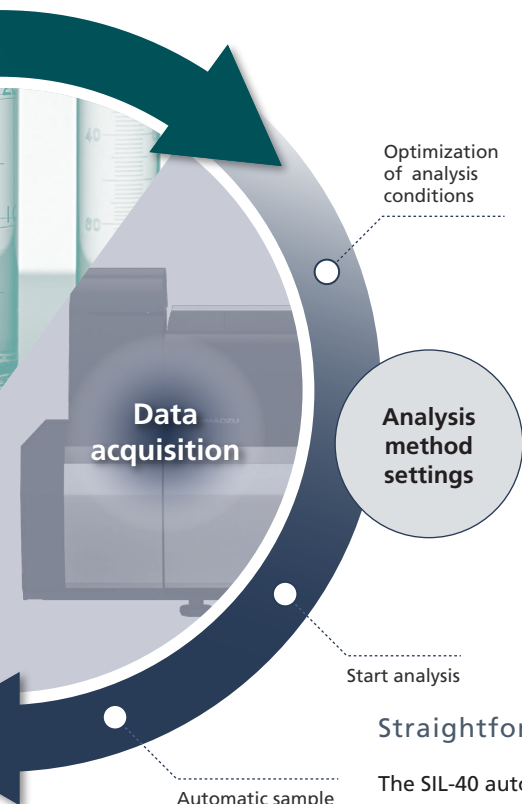

## Straightforward pretreatment saves labor

The SIL-40 autosampler series has programmable micro-volume liquid handling capabilities. Apply these sample pretreatment parameters from a simple graphic interface, reducing labor and increasing precision in co-injection, derivatization, etc.

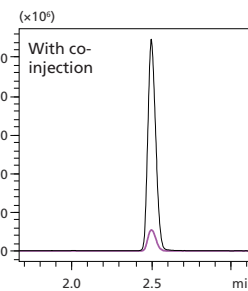
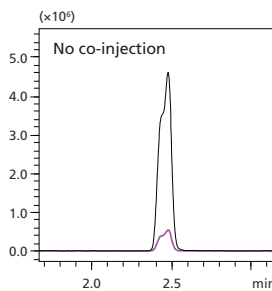
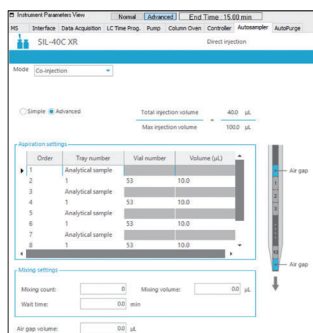

Automatic co-injection with water matches mobile phase conditions, preserving peak shape for early eluters

# Software Solutions from Acquisition to Data Review

## LabSolutions Connect™ / LabSolutions Insight™

LabSolutions Connect and LabSolutions Insight provide support for the entire analytical workflow, from optimization of MS conditions to data processing, to achieve maximum efficiency.

### Project file management made simple

Automatically stay organized with Connect's file management system. File locations are automatically determined by file type, enabling the technician to carry out analysis or data processing without having to remember file paths. Analyte concentrations and other sample results can be saved as a data processing results file. Multiple processing methods can be used on the same data set, with results stored separately, enabling processing parameter optimization and easy results retrieval.

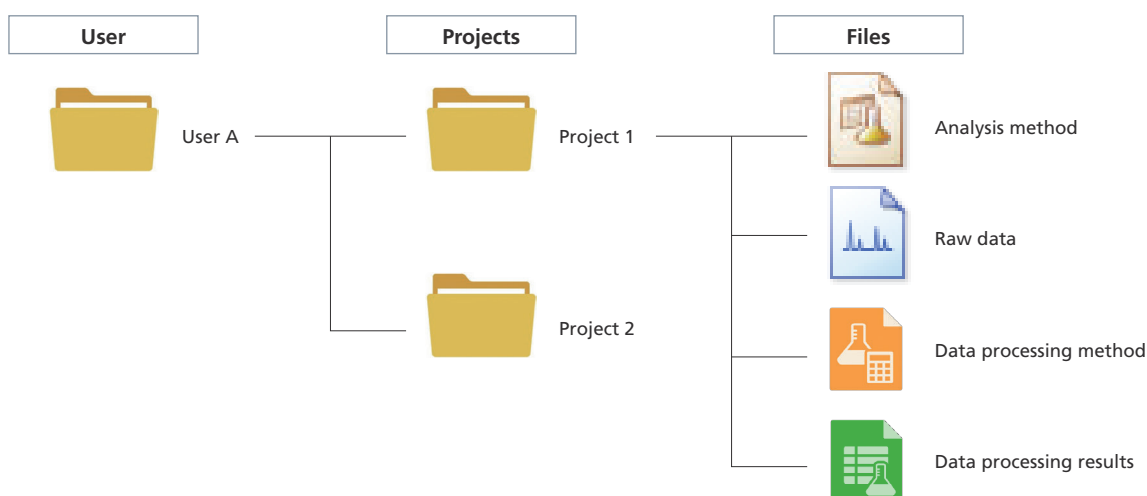

### MRM and ion source optimization

MRM parameters (precursor ion  $m/z$ , product ion  $m/z$ , voltages) and ion source parameters (gas flow rate, temperature) are automatically optimized. Just one round of comprehensive optimization maximizes sensitivity, taking into consideration polarity, adduct ions, charge number etc. The results of this process can be viewed on a graph using the data browser function. The MRM optimization results screen simultaneously displays a chromatogram, a spectrum, and each voltage. From the MRM optimization results screen, check how the signal intensity changes with variations in each parameter.

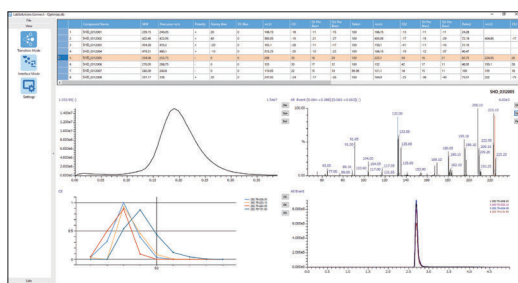

**MRM optimization**

Review screen for MRM optimization simultaneously displays precursor ion, product ion, and voltage results.

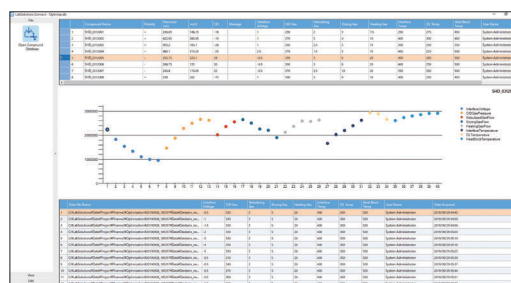

**Ion source optimization**

Review screen for source optimization graphically displays the successive results of each parameter modification.

## Simple method creation and batch creation

LabSolutions Connect organizes optimized results in a dedicated database for easy retrieval. Simply select the target compounds from the database to create a method. Existing method files can be read into the database so that all method file information can be managed together. During the creation of sample acquisition batches, the position of vials is shown on the screen so that settings can be applied easily without risk of mistakes. The project management function prevents the user from accidentally overwriting files from a different project.

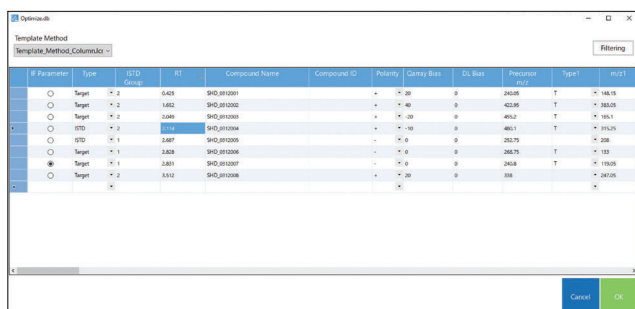

Method creation window

Simply select the compounds to be analyzed and the method is automatically generated.

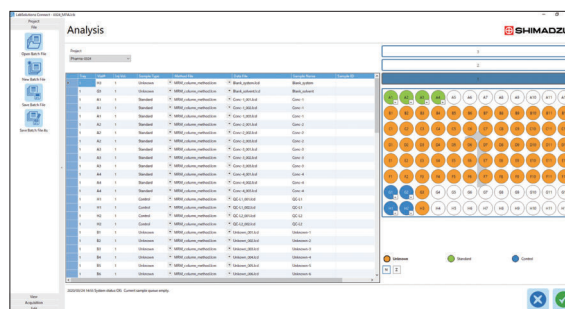

Batch creation window

Vial positions and sample types are shown graphically.

## Efficient data review

LabSolutions Insight is the ideal environment for sample data review. Toggle between sample and compound review modes based on user preference. The multiple chromatogram display accordingly presents all samples for a particular analyte, or all analytes for a particular sample. All chromatograms can simultaneously be zoomed in or out, or docked in a separate monitor to suit analyst needs.

Color-coded flags enable the reviewer to easily spot problem samples for speedy and accurate processing. Flags can be set for a wide variety of QC parameters, not only for values exceeding limits, but also approaching limits. Use standard report templates or file output for universal laboratory information systems integration.

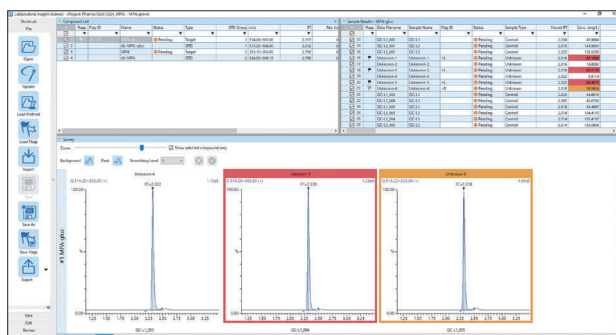

Multi-chromatogram survey display

Easily carry out peak corrections for multiple chromatograms, and use the flagging function to keep track of samples that need to be checked.

UFMS, the Analytical Intelligence logo, IonFocus, UFsweeper, UF-Qarray, UF-Lens, Nexera, LabSolutions Connect and LabSolutions Insight are trademarks of Shimadzu Corporation.



Shimadzu Corporation  
[www.shimadzu.com/an/](http://www.shimadzu.com/an/)

**For Research Use Only. Not for use in diagnostic procedures.**

This publication may contain references to products that are not available in your country. Please contact us to check the availability of these products in your country.

Company names, products/service names and logos used in this publication are trademarks and trade names of Shimadzu Corporation, its subsidiaries or its affiliates, whether or not they are used with trademark symbol "TM" or "®".

Third-party trademarks and trade names may be used in this publication to refer to either the entities or their products/services, whether or not they are used with trademark symbol "TM" or "®".

Shimadzu disclaims any proprietary interest in trademarks and trade names other than its own.

The contents of this publication are provided to you "as is" without warranty of any kind, and are subject to change without notice. Shimadzu does not assume any responsibility or liability for any damage, whether direct or indirect, relating to the use of this publication.